



Installation and Operations Manual

H-IM-LLC

February 2018

Part No. 25092501

Replaces H-IM-LLC (01/2014)

Lead Lag Control System

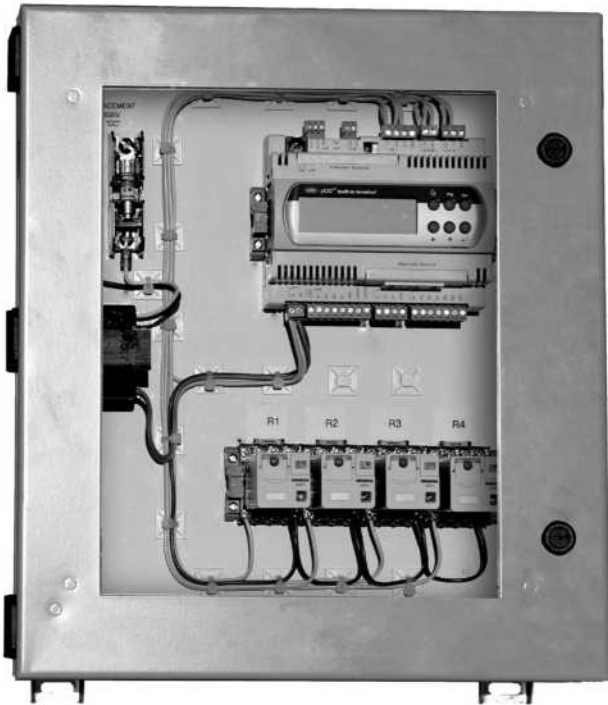

Table of Contents

General Safety Information	2	Set Points (Page 2)	7
Inspection	2	Set Points (Page 3)	7
Warranty Statement	2	Control Setup	8
Introduction	3	Sensor Settings	8
Control Box	3	Control Deadband (Page 1)	8
Lead Lag Control System Placement	4	Control Deadband (Page 2)	8
Check Out and Start Up	4	Stage Delay Timers	9
Sequence of Operation	4	Compressor Timers	9
Electrical Connections	5	Default Settings	9
User Interface	6 - 9	In-Warranty Return Material Procedure	10
Main Status	6	Parts by InterLink	10
Sensor Status	6	InterLink Lead Lag Control System Parts List	10
Output Closure Time	6	Notes	11
Set Points (Page 1)	7		

General Safety Information

1. Installation and maintenance to be performed only by qualified personnel who are familiar with this type of equipment
2. Make sure that all field wiring conforms to the requirements of the equipment and all applicable national and local codes.
3. Make sure all power sources are disconnected before any service work is done on units.

Inspection

Responsibility should be assigned to a dependable individual at the job site to receive material. Each shipment should be carefully checked against the bill of lading. The shipping receipt should not be signed until all items listed on the bill of lading have been accounted. Check carefully for concealed damage. Any shortage or damages should be reported to the delivering carrier. Damaged material becomes the delivering carrier's responsibility, and should not be returned to the manufacturer unless prior approval is given to do so. When uncrating, care should be taken to prevent damage. Heavy equipment should be left on its shipping base until it has been moved to the final location. Check the serial tag information with invoice. Report any discrepancies to your Heatcraft Refrigeration Products Sales Representative.

Warranty Statement

Seller warrants to its direct purchasers that products, including Service Parts, manufactured by SELLER shall be of a merchantable quality, free of defects in material or workmanship, under normal use and service for a period of one **(1) year from date of original installation, or eighteen (18) months from date of shipment** by SELLER, whichever first occurs. Any product covered by this order found to Seller's satisfaction to be defective upon examination at Seller's factory will at SELLER's option, be repaired or replaced and returned to Buyer via lowest common carrier, or SELLER may at its option grant Buyer a credit for the purchase price of the defective article. Upon return of a defective product to SELLER's plant, freight prepaid, by Buyer, correction of such defect by repair or replacement, and return freight via lowest common carrier, shall constitute full performance by SELLER of its obligations hereunder.

SELLER shall have no liability for expenses incurred for repairs made by Buyer except by prior, written authorization. Every claim on account of breach of warranty shall be made to SELLER in writing within the warranty period specified above – otherwise such claim shall be deemed waived. Seller shall have no warranty obligation whatsoever if its products have been subjected to alteration, misuse, negligence, free chemicals in system, corrosive atmosphere, accident, or if operation is contrary to SELLER's or manufacturer's recommendations, or if the serial number has been altered, defaced, or removed.

Seller makes no express warranties except as noted above. All implied warranties are limited to the duration of the Express Warranty. Liability for incidental and consequential damages is excluded. The forgoing is in lieu of all other warranties, express or implied, notwithstanding the provisions of the uniform commercial code, the Magnuson-Moss Warranty - Federal Trade Commission Improvement Act, or any other statutory or common law, federal or state.

SELLER makes no warranty, express or implied, of fitness for any particular purpose, or of any nature whatsoever, with respect to products manufactures or sold by seller hereunder, except as specifically set forth above and on the face hereof. It is expressly understood and agreed that SELLER shall not be liable to buyer, or any customer of buyer, for direct or indirect, special, incidental, consequential or penal damages, or for any expenses incurred by reason of the use or misuse by buyer or third parties of said products. To the extent said products may be considered "consumer products," As defined in Sec. 101 of the Magnuson-Moss Warranty - Federal Trade Commission Improvement Act, SELLER makes no warranty of any kind, express or implied, to "consumers," except as specifically set forth above and on the face hereof.

The following conditions should be adhered to when installing this unit to maintain the manufacturers warranty:

- (a) The power supply to the unit must meet the following conditions:
 - A. Single phase must be within +10% or -5% of nameplate ratings.
 - B. Phase imbalance cannot exceed 2%.
- (b) All control and safety switch circuits must be properly connected according to the wiring diagram.
- (c) The factory installed wiring must not be changed without written factory approval.
- (d) All equipment is installed in accordance with local, state and national electrical code specified minimum clearances.

INTRODUCTION

The Lead Lag thermostat control system provides thermostat and auto-rotation functionality for 2 to 4 refrigeration systems in order to provide equal system run times. The number of temperature inputs utilized can be from 1 to 4. The control temperature can use a single sensor input or multiple sensors can be configured to control by average, maximum or minimum temperature.

The standard operation of the control system is to use all the systems it controls to maintain the box temperature desired. The control system does this by monitoring the rate of change of the box temperature and turning on or off systems based on the rate of change towards the desired temperature. At any given moment all systems or no systems may be running depending on the current box temperature and load. Algorithms are built in to stage the systems on so as to keep even run time between the systems. Staging time of the systems and system safeties are also configurable as described later in this manual.

Control Box

The standard ETL certified control box is NEMA 4 rated.

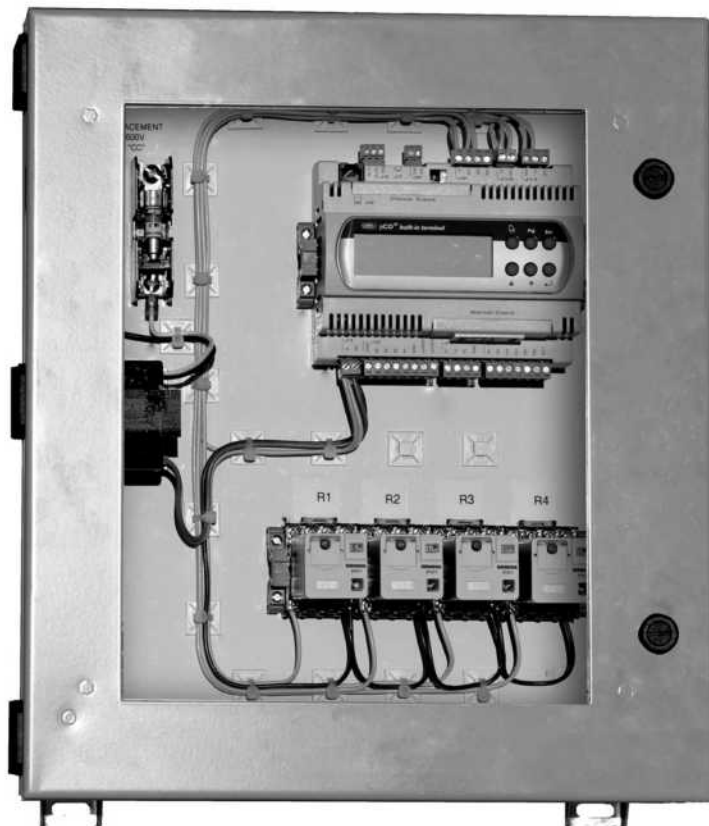

Lead Lag Control System Placement

The Lead Lag control package is designed to be wall mounted outside the area being controlled. The control enclosure features four mounting tabs to be used to securely mount the enclosure to the wall. Mounting hardware and method should be sufficient to hold the weight of the enclosure. In areas requiring water resistance, care should be taken during mounting and installation to maintain the enclosures NEMA 4 rating. Locations selected should meet the following requirements:

- 1.) Ambient temperature should be between 15° F and 140° F.
- 2.) Relative humidity should be below 90% and be non-condensing.
- 3.) Location should not have objectionable vibrations.

Check Out and Start Up

After the installation has been completed, the following points should be covered before the system is placed in operation:

Prior to Applying Power

- 1.) Confirm incoming power supply matches the unit's specifications.
- 2.) Confirm system wiring matches electrical wiring diagram.
- 3.) Check all electrical connections. Ensure they are all tight.

After Applying Power

- 4.) Set temperature and alarm set points.
- 5.) Confirm control system parameter settings.

Sequence of Operation

On power-up, the control system will begin to modulate the relay outputs in order to meet the space temperature set point. The first system that is available will turn on based on previous run time in conjunction with the minimum compressor off and stage delay timers. Once the stage delay timer has been satisfied, the next system with the lowest run time will be turned on if the temperature and the rate of change (slope) set points are not satisfied. Once the space temperature has been satisfied, the control system will stage the systems off based on the control scheme being utilized (output run time or first in-first out), and the stage delay timer. Once cycled off, a system will remain off until the minimum off cycle time set point has been satisfied.

Electrical Connections

Thermostat connections are normally open and are connected through the NO1, NO2, NO3, NO4 and C1, C4. Sensors are connected to the B terminals as shown in the diagram below using B1, B2, B3, B4 and GND. The alarm output is connected through NO5, NC5, and C5.

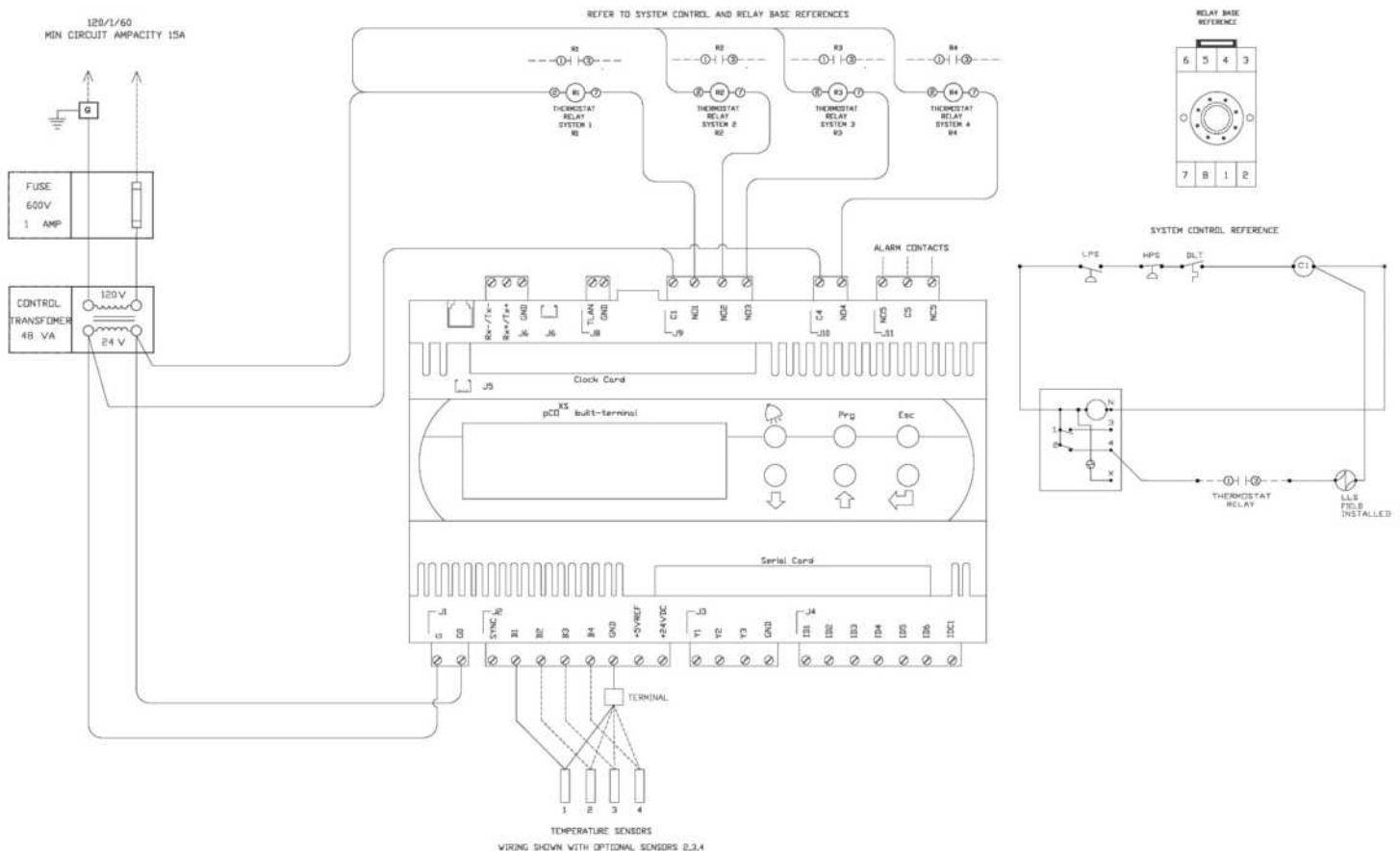

Warnings

Electrical connections must only be completed by a qualified electrician.

A power supply other than the type specified may seriously damage the system.

Separate as much as possible the sensor wiring from wiring carrying inductive loads and power wiring to avoid possible electromagnetic disturbance. Never lay power wiring and sensor wiring in the same conduits. Do not install the sensor wiring in the immediate vicinity of power devices (contactors, circuit breakers or similar).

Reduce the path of sensor wiring as much as possible and avoid spiral baths that enclose power devices.

Avoid direct contact with internal electronic components.

Connection errors (and connections other than those indicated in this manual) may involve danger to the users and may cause faults on the instruments and components connected.

User Interface

The user interface shows the system status as well as allows for changes to the system parameters.

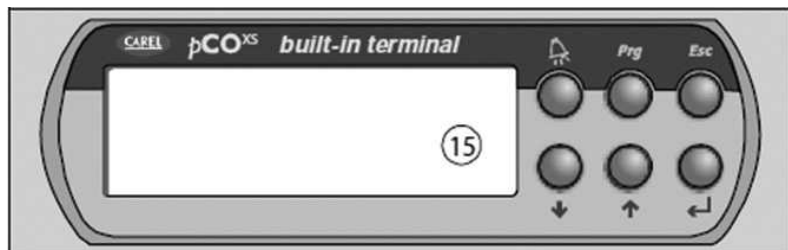

- Prg**
Program Button
- Esc**
Escape Button
- Left Arrow**
Enter Button
- Up Arrow**
Up Button
- Down Arrow**
Down Button
- Alarm Bell**
View Active Alarms

Main Status

Press the **Esc** button to return to the Main Status Screen at any time.

Cntrl Temp: is the current space temperature reading. This temperature shows the actual or calculated temperature based on the configuration selected.

Set Pnt: is the desired space temperature.

System: Shows the overall status of the control system and the status of each system. In the example above, refrigeration system 1 is on and system 2, 3 & 4 are off (1 0 0 0).

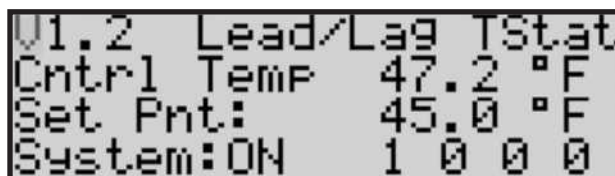

Sensor Status

To enter the sensor status screen, press the down button with the cursor in the top left corner of the display.

This page displays the temperature sensor's current readings along with the average temperature. If a sensor is not connected no value will display here. Temperature sensor is 27.28 kOhm at 32°F.

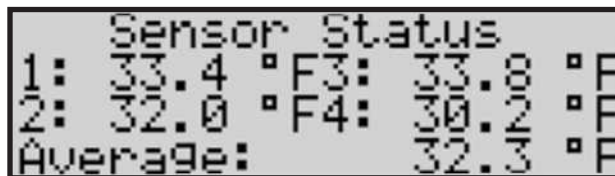

Output Closure Time

To enter the output closure time screen, press the down button with the cursor in the top left corner of the display from the sensor status page.

This page displays the total time that each relay output has been energized (closed).

You can reset all the times by hitting the **Enter** button and changing "Reset:No" to "Reset:Yes".

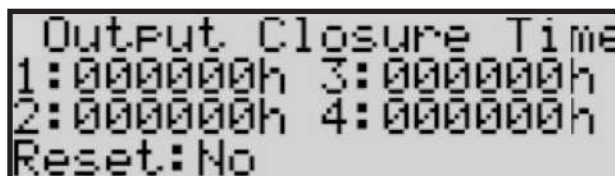

This operation cannot be undone and will reset all four times.

Set Points (Page 1)

Press the **Prg** button to enter the main Set Points screen.

To change a parameter, press the **Enter** button to navigate to the desired parameter.

Once at the desired parameter, press the **up** or **down** buttons to change the value of the parameter. Press **Enter** again to save the change.

Control Set: This is the desired space temperature set point. Control Set set point range: -99.9°F to 99.9°F in 0.1°F increments.



System: This will turn on or off the overall functionality of the control system.

All systems will turn off and will not turn on until the control system has been turned on again.

Cntrl Value: This is the actual space temperature value and cannot be changed.

Set Points (Page 2)

To enter page two of the set point screen, press the down button with the cursor in the top left corner of the display.

Slope: The rate of change of the space temperature in degrees per minute that is deemed sufficient without needing to turn on another stage of cooling. Slope set point range: -10.0°F to 10.0°F in 0.1°F increments.

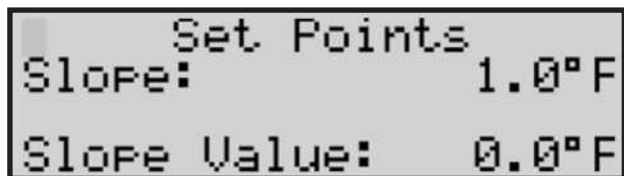

Slope Value: This is the current slope value in real time and cannot be changed.

The slope is used to keep additional stages from coming on if the space temperature is pulling down at a fast rate. When the space temperature is increasing the slope value will be a positive number and when the space temperature is decreasing the slope value will be a negative number.

Set Points (Page 3)

To enter page three of the set point screen, press the down button with the cursor in the top left corner of the display.

Hi Alarm: This is the high temperature alarm set point. Hi Alarm set point range: -99.9°F to 99.9°F in 0.1°F increments.

Low Alarm: This is the low temperature alarm set point. Low Alarm set point range: -99.9°F to 99.9°F in 0.1°F increments.

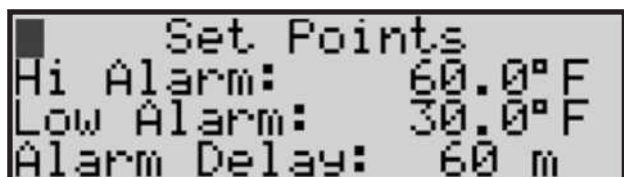

Alarm Delay: This is the time delay before the control system will alarm due to a high or low temperature alarm. Alarm Delay set point range: 0 minutes to 999 minutes in 1 minute increments.

In addition to the high and low box temperature alarm, the control system will also alarm in the event there are either no temperature sensors connected or if all the sensors connected have failed. This alarm is immediate and is not affected by the alarm delay.

Control Setup

To enter the control setup screen press the Prg and the Esc at the same time.

Cntrl Sensor: This setting selects which sensor or calculation to use in the box temperature measurement. The choices are **T1, T2, T3, T4, Average, Maximum, and Minimum**. The average setting automatically calculates the average temperature based on the number of sensor(s) connected and their current measurements.

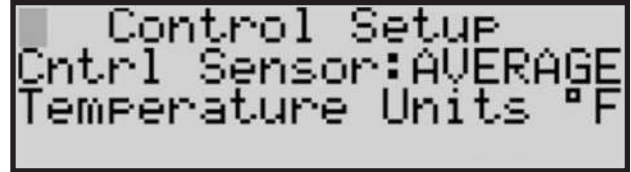

Temperature Units: °F or °C.

Sensor Settings

Press the **Down** button to page through each sensor settings.

Ch: Input Sensor Channel

NTC: Sensor Type

Offs: Sensor offset calibration and actual value

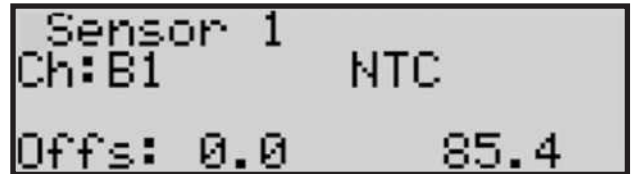

Control Deadband (Page 1)

Direction: Direct or Reverse Acting. Refrigeration should always be direct acting.

Num Stages: The number of refrigeration systems attached to controller (2 – 4).

Control: Applies to the method of energizing the stages of cooling. OUTPUT TIME or FIFO.



OUTPUT TIME chooses the next output to energize based on which output has the least amount of time energized (times can be seen on the output closure time screen). It chooses the next output to de-energize based on which output has the most amount of time energized.

FIFO chooses the next output to energize and de-energize based on a First In First Out (FIFO) algorithm. The first output that was energized will be the first output to be de-energized.

Control Deadband (Page 2)

Diff +: The number of degrees above set point to enable a call for a cooling stage.

Diff -: The number of degrees below set point to disable a call for a cooling stage. The Deadband differentials can be set from 0 to 10°F in 0.1°F increments.

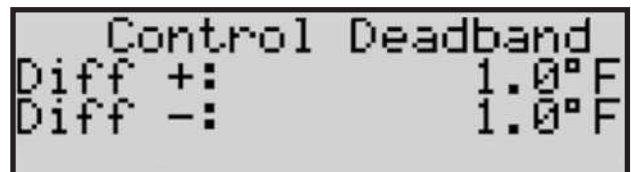

Stage Delay Timers

Stage Up: The minimum delay before the control system can energize an output. Stage Up set point range: 0 seconds to 32000 seconds in 1 second increments.

Stage Down: The minimum delay before the control system can de-energize an output. Stage Down set point range: 0 seconds to 32000 seconds in 1 second increments.

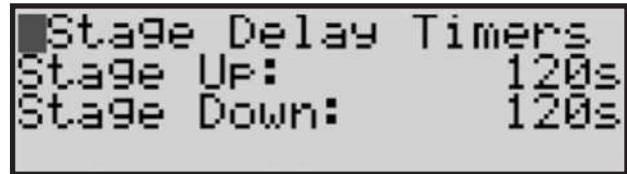

Compressor Timers

Min Off: The minimum stage off time for each output. Min Off set point range: 0 seconds to 999 seconds in 1 second increments.

Min On: The minimum stage on time for each output. Min On set point range: 0 seconds to 999 seconds in 1 second increments.

2 Starts Same: The minimum time between the same output being energized twice. 2 Starts same set point range: 0 seconds to 999 seconds in 1 second increments.

2 Starts Diff: The minimum time between two different outputs being energized. 2 Starts Diff set point range: 0 seconds to 999 seconds in 1 second increments.



Default Settings

Parameter	Setting	Units
Control set point	45	°F/°C
System On/Off	On	
Slope	1	°F/°C
High alarm set point	60	°F/°C
Low alarm set point	30	°F/°C
Alarm Delay	60	Minutes
Control Sensor	Average	
Temperature Units	F	
Sensor Type	NTC	
Sensor Offset	0	°F/°C
Direction	Direct	
Number of Stages	2,3, or 4	
Control	Output time	
Differential +	1	°F/°C
Differential -	1	°F/°C
Stage up delay	120	Seconds
Stage down delay	120	Seconds
Minimum Off time	60	Seconds
Minimum On time	60	Seconds
2 starts same units	60	Seconds
2 starts different units	60	Seconds

In-Warranty Return Material Procedure

Material may not be returned except by permission of authorized factory service personnel of Heatcraft Refrigeration Products in Stone Mountain, Georgia. A "Return Goods" tag will be sent to be included with the returned material. Enter the required information on the tag in order to expedite handling at our factories and prompt issuance of credits. All parts shall be returned to the factory designated on the "Return Goods" tag, transportation charges prepaid.

The return of a part does not constitute an order for replacement. Therefore, a purchase order must be entered through your nearest Heatcraft Refrigeration Products representative. The order should include part number, model number and serial number of the unit involved.

Following our careful inspection of the returned part and if it is determined that the failure is due to faulty material or workmanship, credit will be issued on customer's purchase order.

Parts by InterLink™

When writing to the factory for service or replacement parts, refer to the model number and serial number of the unit as stamped on the serial plate attached to the unit. If replacement parts are required, mention the date of installation of the unit and date of failure, along with an explanation of the malfunctions and a description of the replacement parts required.



InterLink™ Lead Lag Control System Parts List

Item	Part Number	Quantity
Temperature Sensor	28988042	1 to 4
Control Relay	2250024	1 to 4
Control Relay Base	2254610	1 to 4
Control Transformer	2254425	1
Control Fuse	22510005	1
2 System Controller	28977042	1
3 System Controller	28977043	1
4 System Controller	28977044	1

This guide is designed to provide only general information. If you need advice about a particular product application or installation, you should consult your Heatcraft or Kysor Warren representative. The applicable specification sheets, data sheets, handbooks, and instructions for Heatcraft or Kysor Warren products should be consulted for information about that product, including, without limitation, information regarding the design, installation, maintenance, care, warnings relating to, and proper uses of each product.

INFORMATION CONTAINED WITHIN THIS GUIDE, IS PROVIDED "AS IS," WITH ALL FAULTS, WITH NO REPRESENTATIONS OR WARRANTIES OF ANY KIND BEING MADE, EITHER EXPRESSED OR IMPLIED, INCLUDING, BUT NOT LIMITED TO, THE IMPLIED WARRANTIES OF MERCHANTABILITY AND FITNESS FOR A PARTICULAR PURPOSE. HEATCRAFT AND KYSOR WARREN SPECIFICALLY DISCLAIM ALL LIABILITY FOR ERRORS OR OMISSIONS IN, OR THE USE, MISUSE OR MISINTERPRETATION OF, ANY INFORMATION CONTAINED IN THIS GUIDE. HEATCRAFT AND KYSOR WARREN DO NOT WARRANT THE ACCURACY, COMPLETENESS OR TIMELINESS OF THE INFORMATION CONTAINED IN THIS GUIDE.

The name behind the brands you trust.™  **HEATCRAFT**
Worldwide Refrigeration

BOHN

KYSOR/WARREN

CLIMATE
CONTROL

InterLINK
Commercial Refrigeration Parts

CHANDLER
REFRIGERATION

LARKIN