



OWNER'S MANUAL

BLAST CHILLER

R290 (PROPANE) REFRIGERANT

PBF4.0



EVERIDGE, INC.

15600 37th Ave N, Suite 100
Plymouth, Minnesota 55446
Phone: 888-227-1629

35°F target
Automatic Soft
Cycle Running **25°F**

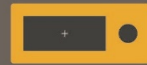
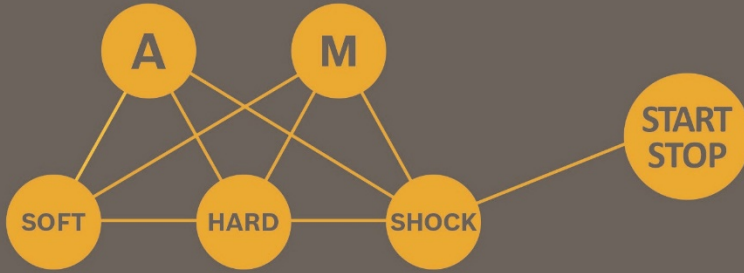
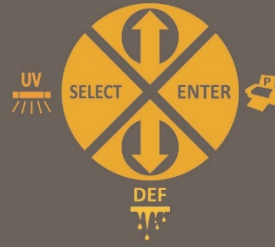

PREPRITE™
BY EVERIDGE

INTRODUCTION

Thank you for purchasing a **Everidge Blast Chiller/Shock Freezer**. This unit has been crafted to provide you with exceptional and reliable service for many years.

Your **Everidge Blast Chiller/Shock Freezer** has been uniquely designed with the refrigeration system and its controller strategically located for easy operation and maintenance. The cabinet is designed with a back step for better condensing unit ventilation. The door has a seamlessly integrated handle built in and a sanitary magnetic gasket which assures a tight seal and is easily removable for cleaning. All of these unique features were designed with you, the operator, in mind.

All of us on the **Everidge** team sincerely appreciate your choosing us, and we are confident that your Blast Chiller/Shock Freezer will exceed your expectations in food preparation and preservation.

This manual will guide you through the operation and programming of the following model: **PBF4.0**

Model **PBF4.0** is designed for:

- 5 - GN 1/1 food pans
- 4 - Full Size Food Pans
- 6 - 4L Gelato Containers
- 6 - 5L Gelato Containers
- 4 - 12L Gelato Containers

PBF4.0 meets or exceeds HACCP, FDA, NSF and all state regulations.

IMPORTANT PRODUCT DATA INFORMATION FOR MODEL PURCHASED

For future reference, please record on this page the applicable data found on the unit's data labels. **It is recommended that this page is preserved during the life of the product.**

Reach-ins: Data label is located on the right side of the cabinet in the upper left corner.

Everidge Commercial Blast Chiller and/or Shock Freezer

Model No. PBF4.0 Serial No. _____ Date Purchased: _____

Refrigerant: 290R

Charge in oz: 150 grams

Compressor: HP: 1/3 FLA: 6.0 AMPS

Fan: HP: 1/4 FLA: 1.0 AMP

Volts: 120VAC PH: 1 Hz: 60 Amps: 7.0 AMPS

Min. Circuit Amps: 15 AMPS Max. Fuse Size (Amps): 15 AMPS

TABLE OF CONTENTS:

INTRODUCTION.....	2
IMPORTANT PRODUCT DATA INFORMATION.....	3
INSTALLATION REQUIREMENTS.....	5
BLAST CHILLER AND SHOCK FREEZER TECHNOLOGY.....	5
OPERATION.....	6
1. AUTOMATIC MODE – SOFT CHILL CYCLE.....	6
2. AUTOMATIC MODE – HARD CHILL CYCLE.....	7
3. AUTOMATIC MODE – SHOCK FREEZE CYCLE.....	8
4. MANUAL MODE - SOFT CHILL CYCLE.....	10
5. MANUAL MODE - HARD CHILL CYCLE.....	11
6. MANUAL MODE - SHOCK FREEZE CYCLE.....	12
PROGRAMMING.....	13
1. INITIAL PROGRAMMING.....	14
2. CYCLE PROGRAMMING.....	17
ELECTRICAL DIAGRAM.....	22
TROUBLESHOOTING GUIDE FOR PBF4.0.....	23
CLEANING INSTRUCTIONS.....	27

INSTALLATION REQUIREMENTS

This model has an electrical cord and plug as standard.

Model PBF4.0 has 2 front swivel casters with brakes and 2 back casters, fixed.

A minimum of four inches is recommended for proper clearance around the unit.

BLAST CHILLER AND SHOCK FREEZER TECHNOLOGY

This appliance rapidly reduces the core temperature of raw or cooked foods to safe cold storage temperature levels.

Blast chilling must attain within two hours a product core temperature of 37 °F / 40 °F and shock freezing must reach a product core temperature of 0 °F within five hours.

The interval between 140 °F and 40 °F, commonly referred to as the “Danger Zone,” is considered the ideal temperature range for bacteria proliferation in most food products.

The methods of blast chilling and shock freezing help avoid food deterioration by retarding or even stopping bacteria proliferation.

After blast chilling, the food can be preserved at temperatures of 37 °F / 40 °F for as long as five days before it is served. Shock freezing will allow food to be safely preserved in a frozen state for several months.

OPERATION

AUTOMATIC CYCLES

*****Important! The AUTOMATIC MODES use both the air and food temperatures to control the cycles.*****

1. AUTOMATIC MODE – SOFT CHILL CYCLE

Note: The food probe must be used with this cycle!

With the display reading **OFF**, press  (ON/OFF).

The display will show:

Choose cycle:
Automatic
Manual

Press  for Automatic mode and the display will show:

Choose Auto Cycle:
Soft **Hard**
Shock

Press  and the display will show:

AUTO SOFT
Ready to Go / Press START
Air: °F Food: °F
75 **73**

Press  The Auto Soft Cycle will start and the display will show:

AUTO SOFT Time:
Running 00:00:48
Air: °F Food: °F
75 **73**

When the food temperature has reached the **TARGET FOOD TEMPERATURE** set in **PROGRAMMING CYCLES** (default 40°F), a beep will sound and the unit will automatically switch to holding mode.

The display will show:

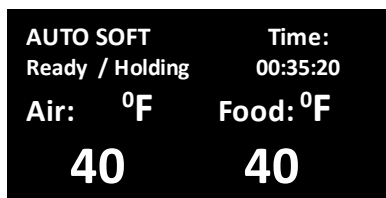

Once the cycle has been stopped, the display will go back to OFF and another cycle may be selected if desired.

2. AUTOMATIC MODE – HARD CHILL CYCLE

Note: The food probe must be used with this cycle!

With the display reading **OFF**, press  (ON/OFF).

The display will show:

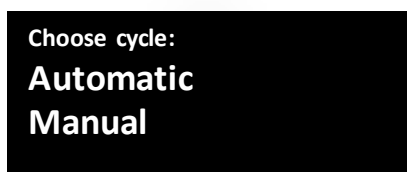

Press  for Automatic mode and the display will show:

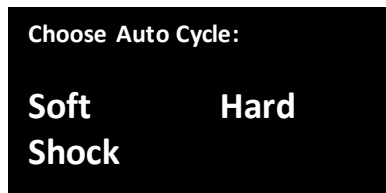

Press  and the display will show:

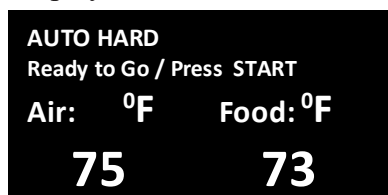

Press  The Auto Hard Cycle will start and the display will show:

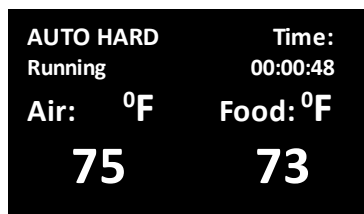

When the food temperature has reached the **TARGET FOOD TEMPERATURE** set in **PROGRAMMING**

CYCLES (default 40°F), a beep will sound and the unit will automatically switch to holding mode.

The display will show:



Once the cycle has been stopped, the display will go back to OFF and another cycle may be selected if desired.

3. AUTOMATIC MODE – SHOCK FREEZE CYCLE

Note: The food probe must be used with this cycle!

With the display reading **OFF**, press  (ON/OFF).

The display will show:

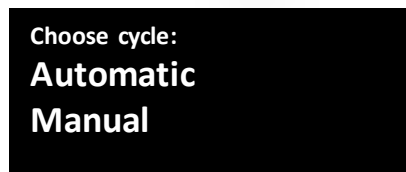

Press  for Automatic mode and the display will show:

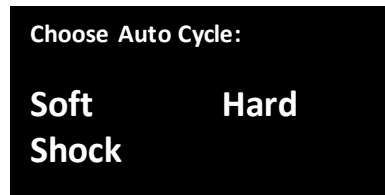

Press  and the display will show:

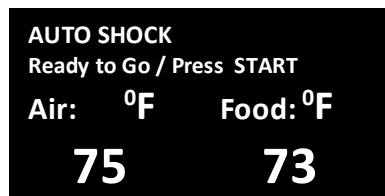

Press  The Auto Shock Freeze Cycle will start and the display will show:

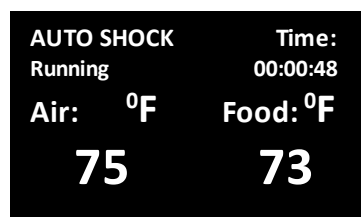

When the food temperature has reached the **TARGET FOOD TEMPERATURE** set in **PROGRAMMING CYCLES** (default 0°F), a beep will sound and the unit will automatically switch to holding mode.

The display will show:

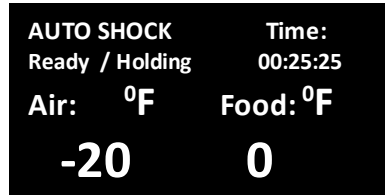

Once the cycle has been stopped, the display will go back to OFF and another cycle may be selected if desired.

MANUAL CYCLES

*****Important! The MANUAL MODES use ONLY time and air probe temperatures to control the cycles.*****

4. MANUAL MODE – SOFT CHILL CYCLE

With the display reading **OFF**, press  (ON/OFF).

The display will show:



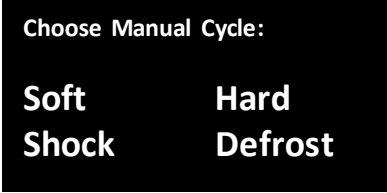

Choose cycle:
Automatic
Manual

Press  for Manual mode and the display will show:



Choose Manual Cycle:
Soft **Hard**
Shock **Defrost**

Press  and the display will show:



MANUAL SOFT
Ready to Go / Press START
Air: ⁰F Food: ⁰F
75 **73**

Press  The Manual Soft Cycle will start and the display will show:



MANUAL SOFT Time:
Running 01:59:59
Air: ⁰F Food: ⁰F
75 **73**

When the set cycle time is reached, a beep will sound and the unit will automatically switch to holding mode.

The display will show:



MANUAL SOFT Time:
Ready / Holding 00:21:00
Air: ⁰F Food: ⁰F
40 **40**

5. MANUAL MODE – HARD CHILL CYCLE

With the display reading **OFF**, press  (ON/OFF).

The display will show:



Choose cycle:
Automatic
Manual

Press  for Manual mode and the display will show:



Choose Manual Cycle:
Soft **Hard**
Shock **Defrost**

Press  and the display will show:



MANUAL HARD
Ready to Go / Press **START**
Air: ^{°F} **75** Food: ^{°F} **73**

Press  The Manual Hard Cycle will start and the display will show:



MANUAL HARD Time:
Running 01:59:59
Air: ^{°F} **75** Food: ^{°F} **73**

When the set cycle time is reached, a beep will sound and the unit will automatically switch to holding mode.

The display will show:



MANUAL HARD Time:
Ready / Holding 00:20:29
Air: ^{°F} **40** Food: ^{°F} **40**

Once the cycle has been stopped, the display will go back to OFF and another cycle may be selected if desired.

6. MANUAL MODE – SHOCK FREEZE CYCLE

With the display reading **OFF**, press  (ON/OFF).

The display will show:

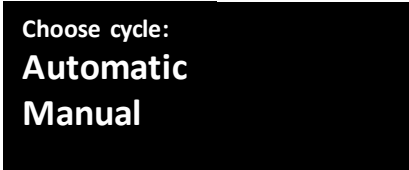

Choose cycle:
Automatic
Manual

Press  for Manual mode and the display will show:

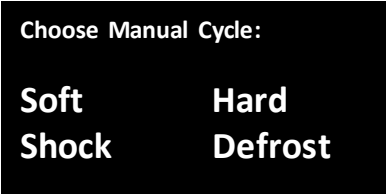

Choose Manual Cycle:
Soft Shock **Hard Defrost**

Press  and the display will show:

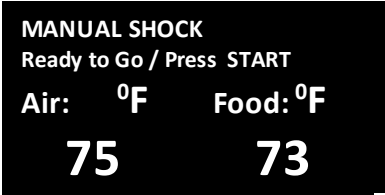

MANUAL SHOCK
Ready to Go / Press **START**
Air: ⁰F Food: ⁰F
75 **73**

Press  The Manual Shock Freeze Cycle will start and the display will show:

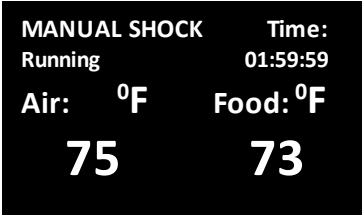

MANUAL SHOCK Time:
Running 01:59:59
Air: ⁰F Food: ⁰F
75 **73**

When the set cycle time is reached, a beep will sound and the unit will automatically switch to holding mode.

The display will show:

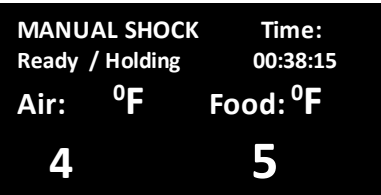

MANUAL SHOCK Time:
Ready / Holding 00:38:15
Air: ⁰F Food: ⁰F
4 **5**

Once the cycle has been stopped, the display will go back to OFF and another cycle may be selected if desired.

*****To stop any cycle before it is complete press  two times*****

PROGRAMMING

From OFF display

Press  and keep it pressed for 5 sec. The display will show:

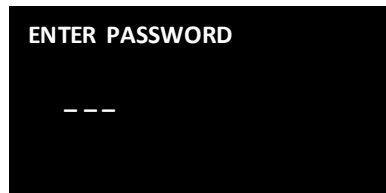

Press once    

The Password is a combination of 3 keys out of 5 keys



followed by 

The display will show:



From  or  we can go to any Programming Menu and then press 

1. INITIAL PROGRAMMING

Press  while you are on 'Initial Programming'. The display will show:

INITIAL PROGRAMMING	
Date & Time Setup	
Temperature Unit	°F
Food Probes	1
High Air Alarm	140°F
Low Air Alarm	-35°F
High Food Alarm	180°F
Low Food Alarm	35°F
Gelato	YES or NO
Ozone	YES or NO
Ozone Time	30 min
USB ID	1
Printer Setup	
Language	English or Spanish
Firmware Version	V 1.01



Press  while you are on 'Date & Time Setup. The display will show:



DATE & TIME	
Date Setup	03/03/20
Time Setup	07:50 PM
Time Zone	UTC-5
Day Light Savings	USA



Press  while you are on 'Date Setup'. The display will show:

DATE SETUP
03/05/2020



The '03' (month) will be blinking

From  or  you select the month and press 

From  or  you select the day and press 



From  or  you select the year and press 

Press  to go back to 'Date & Time'

Press  to go to 'Time Setup' and press 

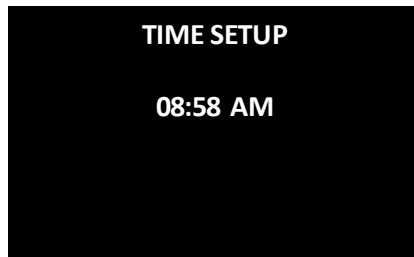

The display will show:



From  or  you select the correct time and press 



The display will go back to 'Day & Time.'

Press  to go back to 'Initial Programming'

Press  to go to 'Temperature Unit' and press 

You can select °F or °C.

Press  or  to go back to 'Initial Programming'.

Press  to go to 'Food Probes' and press 



You can select the number of food probes from 1 to 3. For this unit, being a small unit, one food probe is recommended.



Press  to go to 'High Food alarm' and press . Keep the setting at the 140 °F (recommended) and press 

Press  to go to 'Low Food alarm' and press . Keep the setting at the 35 °F (recommended) and press 

Press  to go to 'Gelato' and press . Make your selection of 'Yes' or 'NO' and press 

Press  to go to 'Ozone' and press . Make your selection of 'Yes' or no and press 

Press  to go to 'Ozone Time' and press . If your selection was 'Yes' for the 'Ozone' you can select the 'Ozone Time' (30 min recommended) and press 



Press  to go to 'USBID' and press 

You can make your selection from 1 to 256.

Press  to go to 'Printer Setup' and press . Make your selection of 'Yes' or 'NO' and press 

Press  to go to the 'MAIN MENU'.

2. CYCLE PROGRAMMING

Press  to go to 'Cycle Programming' and press . The display will show:

CYCLE PROGRAMMING
Auto Parameters
Manual Parameters
Defrost Parameters

Press  while you are on 'Auto Parameters'. The display will show:

AUTO CYCLE PROGRAMMING
Auto Soft Parameters
Auto Hard Parameters
Auto Shock Parameters

Press  while you are on 'Auto Soft Parameters'. The display will show:

AUTO SOFT PARAMETERS
Low Air 28°F
High Air 35°F
Target Food 40°F
Hold Low 35°F
Hold High 42°F

From  you can select any parameter, press  and you can make changes by pressing  or 

Press **ENTER** or **SELECT** to go back to 'Auto Soft Parameters'

Press **SELECT** to go back to 'Auto Cycle Programming'.

Press  to go to the 'Auto Hard Parameters' and then press **ENTER** The display will show:

AUTO HARD PARAMETERS	
Zone 1 Low Air	0°F
Zone 1 High Air	10°F
Break Temp	60°F
Zone 2 Low Air	28°F
Zone 2 High Air	35°F
Target Food	40°F
Hold Low	35°F
Hold High	42°F

From  you can select any parameter, press **ENTER** and you can make changes by pressing  or 



Press **ENTER** or **SELECT** to go back to 'Auto Hard Parameters'.

Press **SELECT** to go back to 'Auto Cycle Programming'.

Press  to go to the 'Auto Shock Parameters' and then press **ENTER** The display will show:

AUTO SHOCK PARAMETERS	
Low Air	-25°F
High Air	-15°F
Target Food	0°F
Hold Low	-4°F
Hold High	3°F



From  you can select any parameter, press **ENTER**

and you can make changes by pressing  or 

Press **ENTER** or **SELECT** to go back to 'Auto Shock Parameters'.

Press **SELECT** to go back to 'Auto Cycle Programming'.

Press **SELECT** to go back to 'Cycle Programming'.



Press  to go to 'Manual Parameters' and press . The display will show:

```
MANUAL CYCLE PROGRAMMING
Manual Soft Parameters
Manual Hard Parameters
Manual Shock Parameters
```

Press  while you are on 'Manual Soft Parameters'. The display will show:

```
MANUAL SOFT PARAMETERS
Low Air          28°F
High Air         35°F
Time             02:00
Hold Low         35°F
Hold High        42°F
```

From  you can select any parameter, press  and you can make changes by pressing  or .

Press  or  to go back to 'Manual Soft Parameters'.



Press  to go back to 'Manual Cycle Programming'.

Press  to go to the 'Manual Hard Parameters' and then press .

The display will show:

```
MANUAL HARD PARAMETERS
Zone 1 Low Air    0°F
Zone 1 High Air  10°F
Zone 2 Low Air   28°F
Zone 2 High Air  35°F
Time             02:00
Zone 1 Time Percent 75%
Hold Low         35°F
Hold High        42°F
```

From  you can select any parameter, press  and you can make changes by pressing  or .



Press  or  to go back to 'Manual Hard Parameters'.

Press  to go back to 'Manual Cycle Programming'.

Press  to go to the 'Manual Shock Parameters' and then press . The display will show:



MANUALSHOCK PARAMETERS	
Low Air	-25°F
High Air	-15°F
Time	04:00
Hold Low	-4°F
Hold High	3°F

From  you can select any parameter, press  and you can make changes by pressing  or .

Press  or  to go back to 'Manual Shock Parameters'.

Press  to go back to 'Manual Cycle Programming'.

Press  to go back to 'Cycle Programming'.

Press  to go to the 'Defrost Parameters' and then press . The display will show:

DEFROST PARAMETERS	
Defrost Type	Air Flow
Auto/Manual	Manual
Manual Time	30 Min
Auto Time	40 Min
Min. Work Time	06:00



From  you can select any parameter, press  and you can make changes by pressing  or .

Press  to go back to 'Defrost Cycle Programming'.



Press  to go back to 'Main Menu'.

The display will show:



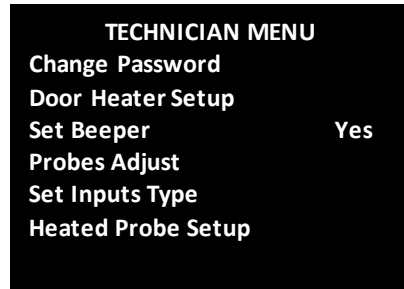

From  go to any 'Technician Menu' and then press  The display will show:

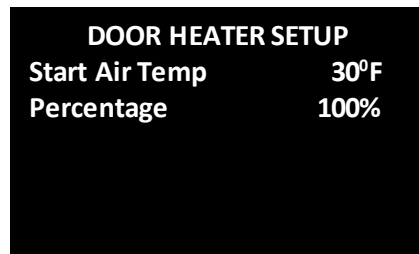

Press  to go to 'Door Heater Setup' and press  The display will show:





Press  to go back to 'Technician Menu'.

Press  to go to the 'Set Beeper' and then press  The display will show:





Press  to go back to 'Technician Menu'.

Press  to go to the 'Probes Adjust' and then press  The display will show:

```
Probes Adjust
Probe Air Adjust    0°F
Probe R Adjust     0°F
Probe Y Adjust     0°F
Probe B Adjust     0°F
```



Press  to go back to 'Technician Menu'.

Press  to go to the 'Set Inputs Type' and then press  The display will show:

```
Inputs Type
Main Door SW Type
EV Door SW Type
High Press SW Type
```

Note: All 'Input Type' have to show 'Normal Close'.

Press  to go back to 'Technician Menu'.

Press  to go to the 'Heated Probe Setup' and then press  The display will show:

```
HEATED R PROBE
Option          Yes
Start Time      5 Sec
Start Temperature 30°F
```

ELECTRICAL DIAGRAM PBF4.0

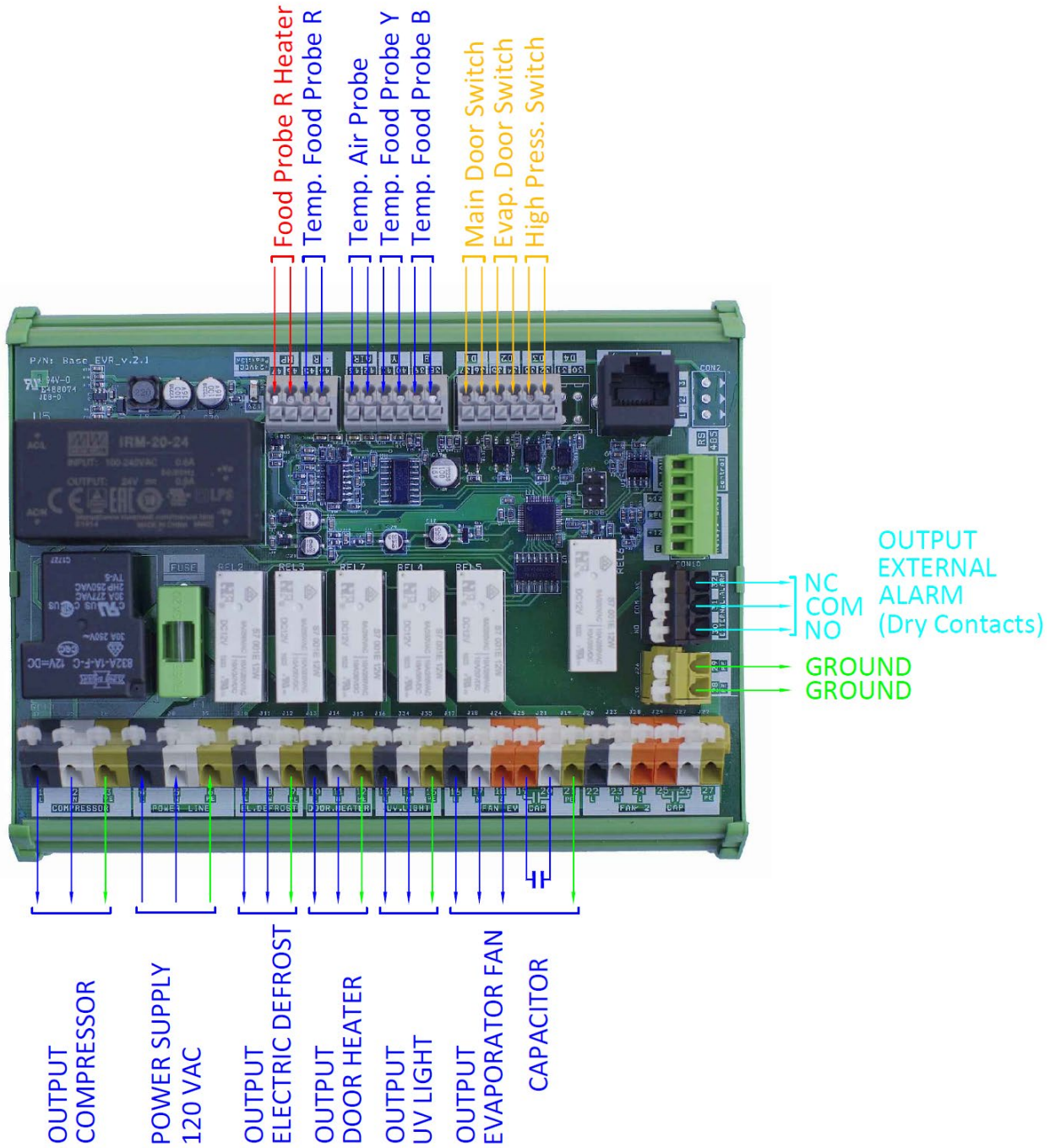

TROUBLESHOOTING GUIDE FOR PBF4.0

***** This section of the manual should be performed by a licensed and certified technician *****

- **PBF4.0** is powered by 115VAC, 60Hz, 15Amps standard outlet.
- The unit comes with a standard 5-15P plug.
- As soon as you have the unit plugged in the display will show "OFF".
- In case the unit is plugged into proper outlet and the display is completely black you need to:
 1. Check the voltage of your outlet and make sure you measure 115VAC.
 2. If you have voltage at your outlet please unplug the unit, take the top off by removing the 4 side screws, plug the unit back into the outlet and with a volt meter set for AC voltage check the voltage at the base board between terminals 4 & 5.
 3. If you do not have voltage, please check the plug connections and the wires L & N & G (PE) going to terminals 4 & 5 & 6.
 4. If you have 115VAC between 4 & 5, please check if the connection cable between the base and the display is connected properly.
- When you start just the Defrost cycle, only the evaporator fan is working. We recommend keeping the door open during the Defrost cycle.
- In case the evaporator fan is not working after you started a Defrost or refrigeration cycle you will need to:
 1. Check the voltage between terminals 16 & 17
 2. Check if the wires at terminals 16, 17, 18, 19, 20 & 21 are secured into the board connectors.
 3. Check that between terminals 19 & 20 you have the connection for the fan evaporator capacitor rated at 14 μ F.
- During any refrigeration cycle, the compressor, the condenser fan and the evaporator fan are working in the same time.
- The compressor and the condenser fan are wired together inside the compressor electrical casing.
- If the compressor or condenser fan do not start when you start a refrigeration cycle:
 1. Please make sure you have 115VAC between terminals 1& 2.
 2. If you have voltage and the compressor and/or the fan condenser do not work, please check the connections inside the compressor electrical casing.

- Please keep in mind, during any refrigeration cycle you have the low air temperature and when you getting to that temperature, the compressor and the fan condenser are off until the air cavity will go up to air high temperature.
In this case, the compressor & condenser fan are off until the cavity air temperature is getting to the high value.
- During the refrigeration cycle the evaporator fan is always working.
- When the refrigeration cycle is completed the unit goes automatically in holding mode.
- During the holding mode, the compressor, the condenser fan and the evaporator fan are ON until the holding low air is achieved and OFF until the holding high air is achieved.

If during troubleshooting you determined that you have a defective component, please follow the instructions below:

Please unplug the unit!!!

Replacing the evaporator fan

Lift up the top stainless steel plate after you take out the 6 screws, 3 on each side of the plate
You disconnect from the electronic power base the wires from these connectors:

1,2,3,4,5,6,16,17, 18, 21, 28, 29, 34, 35, 42, 43, 44, 45

Using a M8 nut driver, remove the 4 mounting nuts for the entire refrigeration module

Now lift the entire refrigeration module and set it on a table

Now open the evaporator door and easily can replace the evaporator fan, take out the thumb screws from the left side

Please make sure that, when you connect a new fan you need to connect the fan wires to the extension cord in this order:

TB (fan) to 1 (extension cord) and this wire will go to number 16 at the electronic base

U2 (fan) to 2 (extension cord) and this wire will go to number 17 at the electronic base

Z2 (fan) to 3 (extension cord) and this wire will go to number 18 at the electronic base

Replacing the evaporator door switch

Open the evaporator door taking out the thumb screws from the left side of the door

On the bottom right you will see the evaporator door switch

Replacing the condenser fan

Lift up the top stainless steel plate after you take out the 6 screws, 3 on each side of the plate
The condenser fan is mounted on a plastic shroud, remove the plastic shroud and replace the fan

Replacing the main door switch

Lift up the top stainless steel plate after you take out the 6 screws, 3 on each side of the plate. You will see the main door switch on the right side looking from the top, it is press fit

Replacing the base electronic board and/or the front OLED electronics

Easy to be replaced, no instructions needed.

VERY IMPORTANT

If you need to replace ANY refrigeration component like: compressor, condenser, evaporator, TXV, high pressure switch, YOU MUST REPLACE THE ENTIRE REFRIGERATION MODULE.

Please follow the procedure as you see at "Replacing the evaporator fan"

After you lift the module, please insert A New Module and connect the wires from the new module to the electronic base

You might see various symbols or texts on the display in case of various alarms in order to determine easily the problem.

Main Door Open

1. Please check the door switch connection D1, terminals 36 & 37.
2. Only in Gelato / Shock Freeze cycle the unit works with the main door open in order to help the operator loading and unloading the product and not losing much of the air cavity necessary during Gelato cycle.

Evaporator Door Open

1. Please check D2 connections between terminals 34 & 35.
2. The evaporator door can be open for cleaning and the thumb screws might not be in place. For this reason, we have an evaporator door switch which does not allow the unit to work until the evaporator door is tight in place.

High Pressure Alarm

The unit is equipped with a high pressure switch and in case you have this message you might have a serious refrigeration issue.

NOTE: For all these three alarms, **MAIN DOOR OPEN / EVAPORATOR DOOR OPEN / HIGH PRESSURE ALARM**, we suggest first to check into programming mode because someone might have had accessed it and change the setting from NORMAL CLOSE to NORMAL OPEN.

The settings for all these three alarms must be set at **NORMAL CLOSE**.

Air N/G

This means the air probe is not good or the connection into the board is not good.

1. Please disconnect the air probe from terminals 42 & 43 and with an ohm meter check if you measure around 109 Ω .

If you measure 109 +/- 5% Ω than, the probe connection inside the terminal is not good.

If you measure crazy values or open values, please replace the air probe.

Food N/G

This means the main food probe which is the R (red food probe) is not good or the connection into the board is not good.

This probe value is around 109 Ω just like the air probe.

The terminals for this probe are 44 & 45.

Main Power lost!

When there is a power outage longer than one hour the unit is not going back to the refrigeration cycle that was running prior to the power loss.

The display will show two alternating messages:

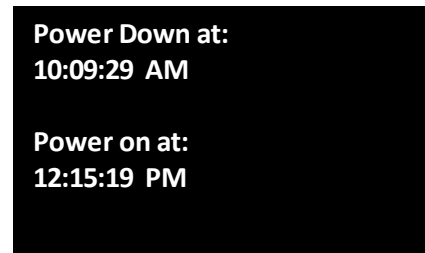
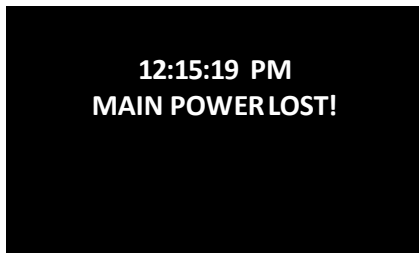

CLEANING INSTRUCTIONS

WARNING: Do not use a pressurized water source such as a hose sprayer to clean the exterior or interior of the unit.

CLEANING THE INTERIOR AND EXTERIOR

The interior cabinet of the blast chiller should be cleaned daily or after each use to avoid altering the taste and aromas of the food.

For cleaning the storage compartment use warm water and mild soap and rinse thoroughly. Avoid the use of strong detergents and abrasive cleaners as they tend to scratch the surface.

Clean the exterior of the unit with warm water, mild soap and a soft cloth. Dampen the cloth and wipe in the direction of the grain.

Clean the door gaskets to provide a tight seal.

Keep blast chiller probes clean of food products to allow for accurate readings and to avoid any potential food contamination.

If drain lines are in use, keep them clean of condensate water to prevent backups.

Do **NOT** use cleaners containing chlorine as this may promote corrosion of the stainless steel. Avoid using sharp tools, especially when cleaning the evaporator.

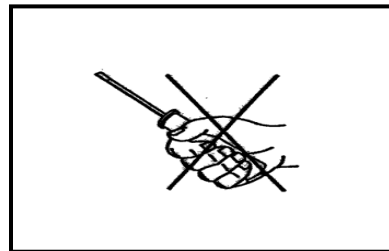
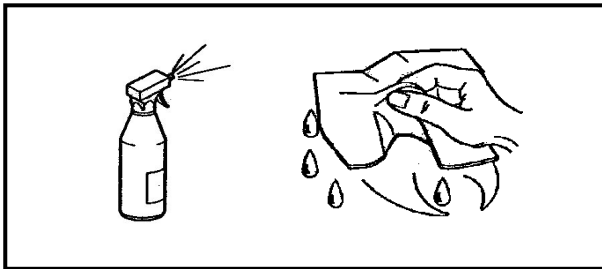

CLEANING THE AIR CONDENSER

Keeping the air condenser clean allows the cabinet to operate more efficiently, allowing the air to circulate freely and use less energy. Cleaning should be scheduled regularly to keep it free from lint and dust accumulation. It is recommended to use a non-metallic brush to remove all the dust and dirt from the condenser fins.

